



By Appointment to  
Her Majesty Queen Elizabeth II  
Suppliers of Commercial Refrigeration  
Foster Refrigerator, King's Lynn

# Undercounter, Space Saver, Prep Tables & XR415 Cabinet & Counter Models

BIT25 Controller & LCD5S Display

Original Operation Instructions

English



00-556435 UK November 2019 Issue 6 5

Foster Refrigerator  
Oldmedow Road  
King's Lynn  
Norfolk, PE30 4JU  
United Kingdom

A division of ITW Ltd



Call: +44 (0)1553 691 122

Email: [support@foster-gamko.com](mailto:support@foster-gamko.com)

[www.fosterrefrigerator.co.uk](http://www.fosterrefrigerator.co.uk)



## Models Applicable to this Manual

### Under Counters

HR150-A	HR150G
HR150STB	HR150-2D
HR200	HR200BK
HR200GBK	HR200Y
HR200STB	HR360
HR360STB	
LR150-A	LR200
LR200BK	LR360

### Space Savers

HR100
HR100G
HR120
HR240
LR120
LR240

### XR415 Cabinets

XR415H
XR415L
XR415G

### ECO Cabinets

HR410
LR410

## Climate Class

Climate class is indicated on the serial plate, shows the temperature & humidity at which this appliance has been tested, for the purposes of establishing values in line with European standards

### Important Note to the Installer:











Please ensure that this document is passed to the user as it contains important guidelines on operation, loading, cleaning and general maintenance and should be kept for reference.

## Electrical Safety

Foster Refrigerator recommends that the equipment is electrically connected via a Residual Current Device; such as a Residual Current Circuit Breaker (RCCB) type socket, or through a Residual Current Circuit Breaker with Overload Protection (RCBO) supplied circuit.

Should it be necessary to replace the fuse. The replacement fuse must be of the value stated on the serial label for the cabinet.

## General Safety

-  Do not store explosive substances such as aerosol cans with a flammable propellant in this appliance.
-  Keep all ventilation openings in the appliance or in the structure of a built in unit clear of any obstructions.
-  Do not use electrical appliances inside the storage compartment.
-  The appliance is air tight when the door is closed therefore under no circumstances should any living body be stored or 'locked in' the appliance.
-  The moving of the appliance should be carried out by competent personnel, ensure that two or more people are used to guide and support the appliance, the appliance should not be moved over uneven surfaces.
-  The emitted sound level of this appliance is 70db(A).
-  To ensure stability the appliance should be located on a flat, level surface, correctly loaded with the castors locked.
-  If the supply cord is damaged, it must be replaced by the manufacturer, it's service agent or similarly qualified persons in order to avoid hazards.
-  Care should be taken to avoid prolonged contact with cold surfaces with unprotected body parts, Correct PPE to be used at all time.
-  When moving the appliance appropriate gloves should be worn, and a relevant risk assessment carried out.

## Disposal Requirements

If not disposed of properly all refrigerators have components that can be harmful to the environment. All old refrigerators must be disposed of by appropriately registered and licensed waste contractors, and in accordance with national laws and regulations.

## Start-Up and Test Sequence

**After unpacking, clean and allow the cabinet to stand for 60 minutes before turning on (cleaning directions supplied within this manual).** Ensure the cabinet is situated on a firm, level surface, away from both hot and cold air sources, as this will affect its performance.









Make sure that a minimum clearance of 50mm above and around the cabinet is available for ventilation and effective operation.

Connect the unit to a suitable mains power outlet and turn the supply on. Please do not plug or unplug the unit with wet hands. The cabinet will start automatically displaying the actual internal temperature of the unit (area where product is stored).

As the operating temperature has been pre-set no adjustments are required. Allow the cabinet to reach its normal operating temperature before loading with product.

## Display Icons and Buttons



Icons		Buttons	
	Alarm Warning		Info & Set Point
	Thermostat Output Active		Manual Defrost & Decrease
	Fan Output Active		Increase & Manual activation
	Defrost Output Active		Standby/Exit
	2nd Parameter Set Active		



## Standby

Pressing the power switch for 5 seconds will turn the unit on or into standby. When in standby the display will show **oFF**.

## Accessing the Info Menu

Press and immediately release the 'i' button then using the ▲ and ▼ buttons select the data you wish to display the value of. When at the desired point press and hold the 'i' button to display the value.

Press the ⏻ button or leave the controller for 30 seconds and the unit will exit the 'Info' menu and resume displaying the current temperature.

## Set Point

To amend the set point press and hold the 'i' button for half a second. Then while keeping the 'i' button pressed use the ▲ and ▼ buttons to set the desired value.

When the 'i' button is released the new value will be stored automatically.

## Keypad Security Settings

This function avoids unauthorised controller access.

Press & release 'i' then use ▲ to select 'Loc'. Press and hold 'i' to change from '4E5' to 'no'. Leave for 10 seconds or briefly press ⏻ to resume.

## Internal Light (where fitted)

The on/off switch is located on the front of the light fitting.

## Shelves, Supports & Drawers

**Shelves** - 'H' models are supplied with slotted removable shelf supports.

The only 'L' models that have fixed shelves that are part of the freezer system and cannot be removed are the LR150-A & XR415L, all other 'L' models have removable shelves.

**Refrigerated Drawers**- can be removed by pulling out to their full extent and lifting so that the roller passes through the slots in the drawer runner. Please ensure drawers are refit to their original position.

## Food

Cover all foods and separate raw and cooked foods to avoid cross contamination.

## Loading and Airflow

Each shelf or drawer is capable of holding up to 25kg of product evenly distributed

Always ensure the air can circulate around/through the stored product.

It is important that for optimal energy performance that adequate airflow is maintained around the perimeter of the shelves, and around all stored products.

On all models please ensure that no product is placed on the unit base.

## Door Lock (Where Fitted)

To lock the door insert the key and turn 90°, turn in the opposite direction to unlock.

## Drawer Removal

This guide applies only to models that have drawers fitted.

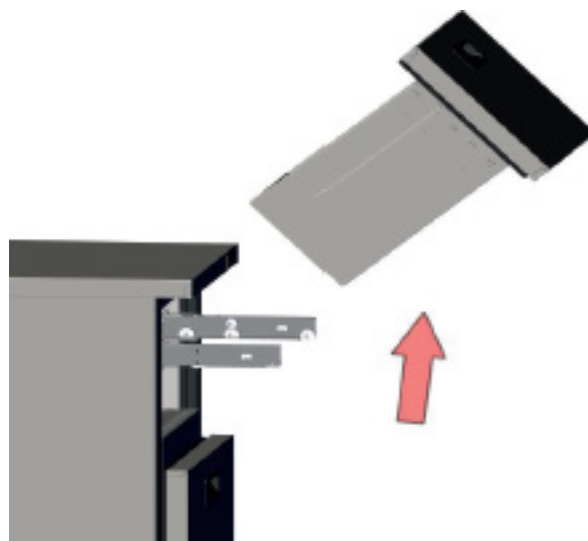
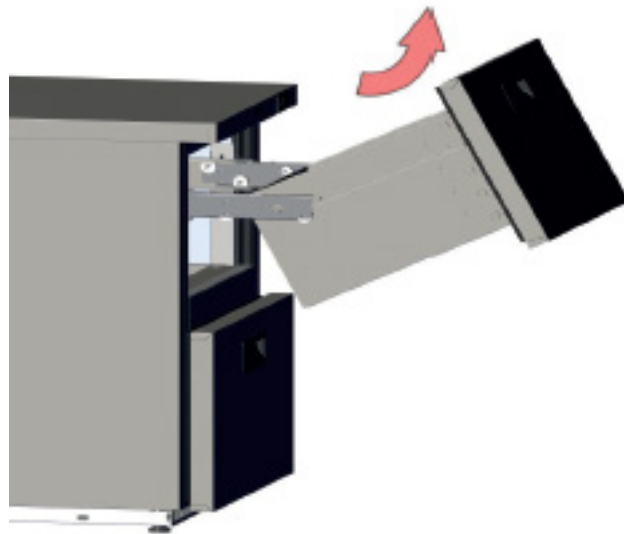
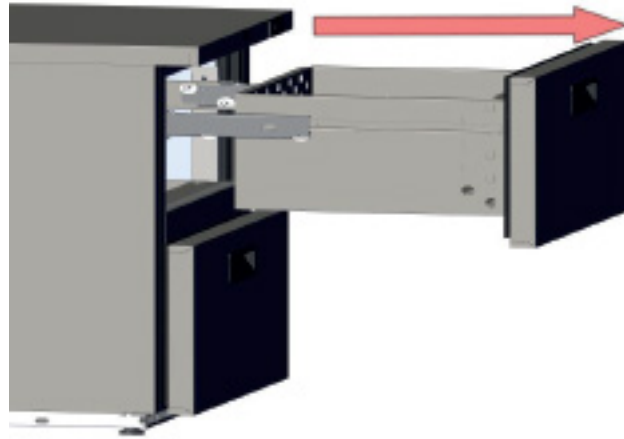



## Defrost

LR150 & LR410 models have static freezer shelves and require manual defrosts. The entire stored product should be removed and placed in a separate freezer. Switch off the mains electrical supply and leave the cabinet door open while placing a bowl inside to catch the water as it defrosts. Once fully defrosted dry the interior of the cabinet and switch on the mains supply.

Do not replace frozen food into the cabinet until it reaches its normal operating temperature.

**All other models** are fitted with a fully automatic defrost system to ensure that the evaporator coil or cooling plate remains free from ice in normal use. 'Melt water' is automatically evaporated using the heat from the refrigeration system.

## Cleaning and Maintenance

Important: Before cleaning, the unit should be put into standby and then the power supply should be turned off at the mains. Please do not plug or unplug the unit with wet hands. Only when cleaning has been completed and the unit is dry should the cabinet be turned back on at the mains.

Suitable P.P.E (Personnel Protective Equipment) should be worn at all times.

Regular Maintenance:

- > As and when required remove all product and shelving (beware of cold and or sharp components) from the unit. Clean exterior and interior surfaces with mild liquid detergent, following the directions on the pack at all times. Rinse surfaces with a damp cloth containing clean water. Never use wire wool, scouring pads/powders or high alkaline cleaning agents i.e bleaches, acids and chlorines as these may cause damage.
- > **Condenser Cleaning:**  
This should take place on a regular basis or as and when required (4 to 6 weeks) by a competent/trained personnel.  
Use a soft brush or vacuum cleaner to remove dirt/dust. If there are any stubborn grease deposits left on or through the condenser call your supplier to carry out a full service (this is normally chargeable). Failure to maintain the condenser may invalidate the warranty of the condensing unit and cause premature failure of the motor/compressor. Do not use a wire brush to clean the condenser. Hoover or brush the air filter (where fitted).
- > All gaskets should be inspected on a regular basis and replaced if damaged. To clean, wipe with a warm damp soapy cloth followed by a clean damp cloth. Finally thoroughly dry.
- > Removable shelves and their supports can be removed for cleaning. The shelves are dishwasher safe; however the vertical supports should be cleaned with warm soapy water then rinsed and dried.

## Troubleshooting

### Alarms/Warnings-

During normal operation the display will show either the temperature or one of the following indicators:

<i>DEF</i>	Defrost In Progress	<i>HP</i>	Condenser High Pressure Alarm
<i>OFF</i>	Controller In Standby	<i>hi</i>	Room High Temperature Alarm
<i>CL</i>	Condenser Clean Warning	<i>Lo</i>	Room Low Temperature Alarm
<i>do</i>	Door Open Alarm	<i>EI</i>	Probe T1 Failure
<i>hc</i>	Condenser High Temperature Alarm	<i>Loc</i>	Keypad Locked
<i>ALr</i>	Generic Alarm		

*(Some icons or switches are only visible during adjustment, when activated by parameters or through operation/manual selection).*

Before calling your supplier please make sure that:

- The plug has not come out of the socket and the mains power supply is on i.e. is the controller illuminated?
- Check to see if the unit is in standby
- The fuse for the cabinet is intact
- The cabinet is positioned correctly – cold or warm air sources are not affecting the performance
- The condenser is not blocked or dirty
- The products are placed in the unit correctly
- Defrost is not in progress or required

If the reason for the malfunction cannot be identified, disconnect the electrical supply to the unit and contact your supplier. When requesting a service call, please quote the model and serial number which can be found on the silver label located on the inside of the unit (starts E.....).

## Require another language?

This manual is also available for download in the following languages:

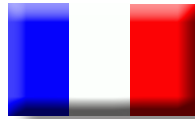

**Français**

**FR**



**Nederlands**

**NL**



**Deutsch**

**D**



**Español**

**ES**



**Česky**

**CZ**

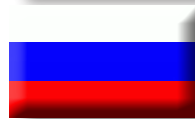

**Русский**

**RU**



**Polski**

**PO**

To download please visit [www.foster-spares.com](http://www.foster-spares.com) and select the appropriate model of refrigerator/ freezer.





> Page Left Blank Intentionally <



> Page Left Blank Intentionally <



> Page Left Blank Intentionally <



**UK Head Office**

Foster Refrigerator  
Oldmedow Road  
Kings Lynn  
Norfolk  
PE30 4JU

a Division of ITW (UK) Ltd

Tel: +44 (0)1553 691 122

Email: [support@foster-gamko.com](mailto:support@foster-gamko.com)

Website: [www.fosterrefrigerator.co.uk](http://www.fosterrefrigerator.co.uk)